

Touch screen floor sensing thermostat



DESCRIPTION

An in wall mounted programmable thermostat for electrical underfloor heating. The thermostat simultaneously works with a floor sensor and in-built air sensor.

- LCD Touch Display with back light
- Child lock function to prevent children from changing the settings
- Supports different temperature setting accordingly with 6 time-modes daily
- Memory settings are retained during a power outage or power restart

TECHNICAL DATA

Supply voltage	230 VAC +15%, -15%, 50/60 Hz
Main switch	Two poles 16 A
Built-in interrupter	2-pole, 16 A
Relay output- heating cable	250 V, max 16 A, resistive load (AC1)
Measuring accuracy	+/- 0.1°C
Floor sensing temperature range	5°C to 90°C
Protection class	IP21
Terminals	max 2.5mm ²
Floor sensor type	NTC, 10KΩ/25°C
Length of floor sensor lead	3 m
Dimensions with frame	H 86 x W 86 x D 40 mm

Button operation

Button	Function
Power	Turn the system on or off.
Mode	Switch between 'Auto mode' or 'manual mode'
Up/down	Adjust the temperature and navigate through system menus. Press both up and down buttons at the same time and hold for 5 seconds to activate child lock.
Clock	Adjust the time and week.

Modes

Manual mode	When this symbol shows, the temperature can be set manually.
Auto mode	When this symbol shows, the thermostat will automatically maintain the temperature based on programming.

WIRING DIAGRAM



Direct connection, one heating cable

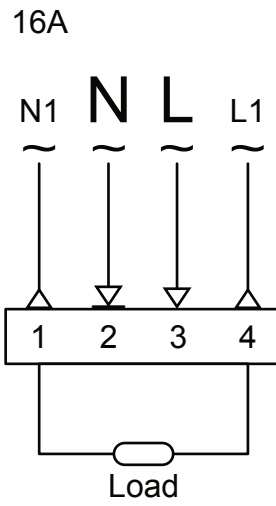

Sensor
 $\beta = 3950$
 $R_{25^{\circ}\text{C}} = 10\text{K}$

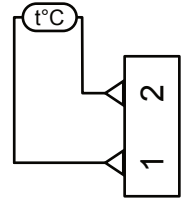

DIMENSIONS

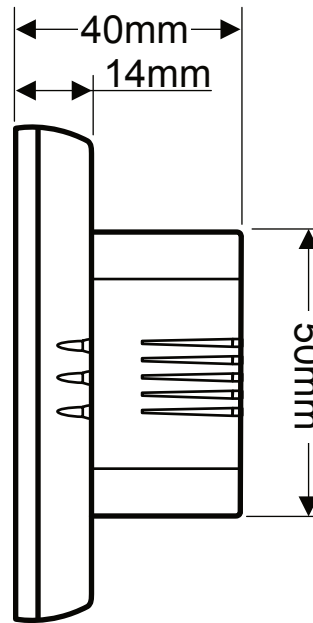
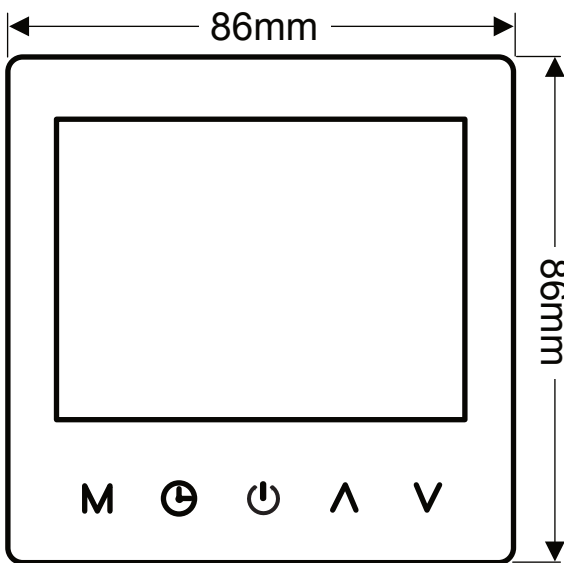

Wall mounting steps

1. Once wiring is complete, push and slide the back panel downwards. A click sound will indicate the back panel can slide freely.

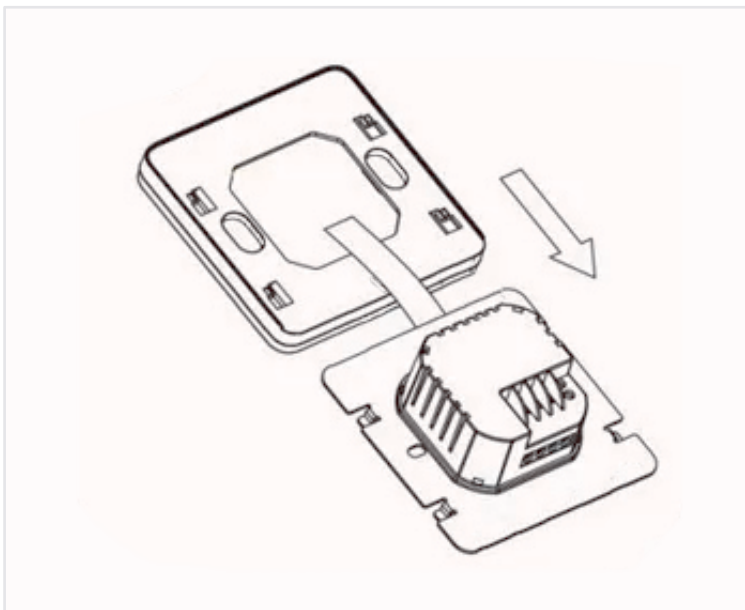

2. Cut a square hole into the wall measuring 60 x 60mm.

Using a Phillips head screw driver, insert the two screws through the mounting plate holes and line them to your own brackets behind the wall.

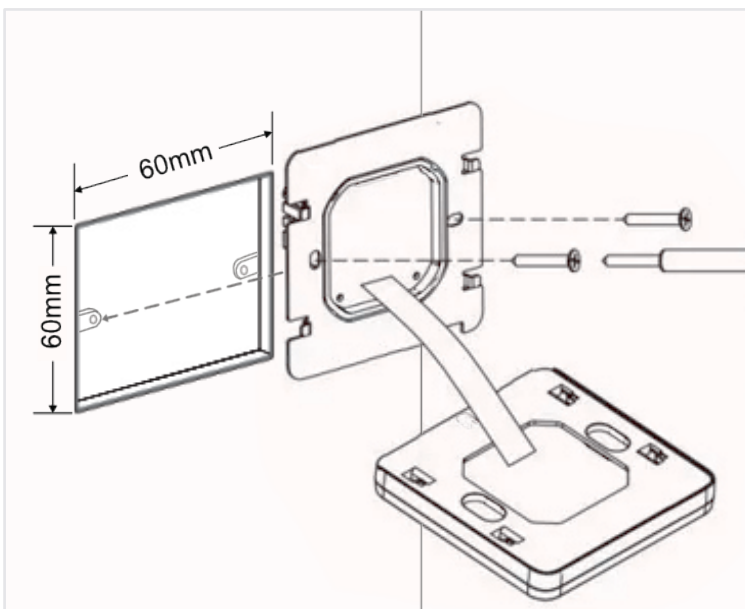

3. Line up the tabs behind the LCD housing and the mounting plate, then push upwards to lock back into position.

Note: The thermostat should be mounted on the wall with air flowing freely around the area intended to heat.

Caution: The mounting location should not be influenced by other heating sources (e.g. sunlight, fireplaces or cooking stoves) or consistently flowing cool air from outdoors.

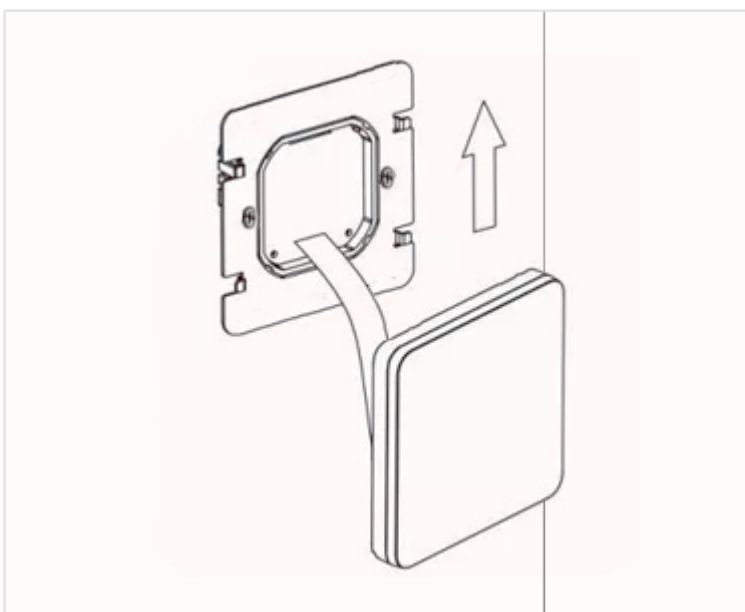









Anti-frozen function

During power off mode, the thermostat will automatically turn on the floor heating system when the room temperature is below 5°C. When the room temperature is above 7°C the thermostat will automatically turn off the floor heating system.

Programming: 6 - event times and temperatures

During power off mode, hold and press "M" and "⊖" buttons for 5 seconds to enter programming mode. Toggle through the settings using the "M" button.









Whilst in programming mode, press "M" button to adjust 'hour', then press "M" button to adjust 'minute'. Press "M" button again to adjust temperature.

Button	Event	Symbol	Time	^ V	Default value	^ V	
M	Week day	01 - Wake up		06:00	Set Set time	20°C	Set temperature
		02 - Leave		08:00		15°C	
		03 - Return (AM)		11:30		15°C	
		04 - Leave (PM)		12:30		15°C	
		05 - Return (PM)		17:00		22°C	
		06 - Sleep		22:00		15°C	
	Week end	01 - Wake up		08:00		22°C	
		02 - Leave		23:00		15°C	

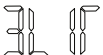
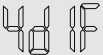
Advanced programming (qualified professional)

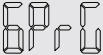
To enter the advanced programming mode, turn off the thermostat and immediately press "M" and "V" at the same time.

Toggle through the following settings by pressing the "M" button.

Symbol	Setting	Default value	xxxxxx
1	 Temperature calibration	-2	Adjust measured temperature range -9°C to 9°C
2	 Sensor mode	IN	IN: Internal air sensor OU: floor sensor AL: both sensors
3	 Over heating protection	60°C	Adjust range: 5°C to 60°C
4	 Switching differential	1°C	Adjust switching differential range: 1°C to 5°C
5	 Anti-frozen function	ON	Turn on (01) / Off (00) Anti frozen function
6	 Different periods of time modes	01	OF: Close 02: 6+1 day mode 01: 5 + 2 day mode 03: 7 + 0 day mode
7	 Maximum temperature	40	Adjust range: 30°C to 90°C
8	 Set the lower limit of temperature	10	Adjust range: 5°C to 20°C
9	 Reset to factory settings	- - -	Press "∧" and hold for 5 seconds, all parameters will reset
10	 Child lock	OFF	ON/OFF (Long press "⊖" unlock)

Troubleshooting

Problem	Solution
Crash	Check the power supply wiring is correct
LCD display garbled	The LCD housing may be incorrectly inserted back into the frame
LCD display functioning, no out	Check for cable damage between the MPU and power board Ensure the null line of live line is connected correctly
Temperature display error	Adjust the panel temperature display by the first option in the advanced tab
Sensor error	Check for damage on the sensor cable Er1: Built-air sensor has a fault Er2: External floor sensor cable has a fault
